



TECHNICAL MANUAL SCREW FASTENING INTERIOR FINISHING



TABLE OF CONTENTS

1. Overview	4
• Drywall boards to metal substructure	4
• Drywall boards to wood substructure	4
• Exterior sheathing boards to metal substructure	4
• Drywall boards to drywall boards	4
• Cement boards to wood or metal substructure	5
• Interior framing screws	5
• Exterior framing screws	6
• Wood boards to metal substructure	7
• Wood boards to wood substructure	7
• Eye lag screws to metal or wood substructure	7
2. Features of interior finishing screws	8
• Head shapes	8
• Insert bit type	8
• Drill Point / Drilling Capacity	9
• Self Drilling Screw capacity by point and diameter	9
• Length Selection	9
• Thread selection	10
3. Environment categories	12
4. Screw pages	14
5. Overview of tools and accessories	54

1. OVERVIEW

Drywall boards to metal substructure

Description	Screw	Page
PBH S		14
PBH S ZINC		15
PBH SD		16
PBH SD ZINC		17
PBH SD CRC		18
PBH S HI/LO		19

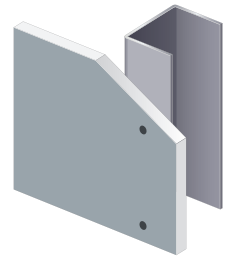

Drywall boards to wood substructure

Description	Screw	Page
PBH S HI/LO		19
PBH S CRS		20
PBH S CRS KCOTE		21

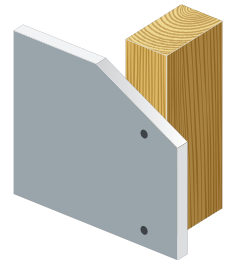

Exterior sheathing boards to metal substructure

Description	Screw	Page
PBH SD ZINC		17
PBH SD CRC		18
PWH S CMT BD		24
PWH SD CMT BD		25



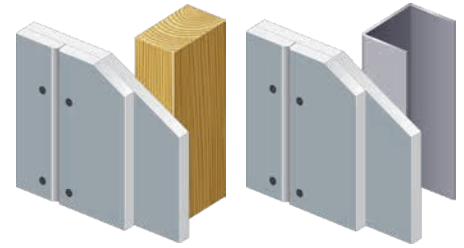

Drywall boards to drywall boards

Description	Screw	Page
PBH S LAM		23









Cement boards to wood or metal substructure

Description	Screw	Page
PWH S CMT BD		24
PWH SD CMT BD		25







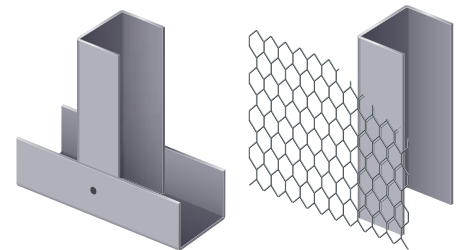







Interior framing screws

Description	Screw	Page
PTH S LATH		26
PTH S LATH ZINC		27
PTH SD LATH ZINC		28
PPH S		29
PPH SD FRMR		30
PPH SD FRMR ZINC		31







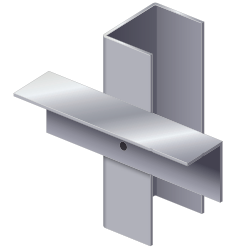

Exterior framing screws

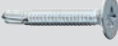
Description	Screw	Page
S-MD PPH #2		32
S-DD PTH 3		33
S-MD PPH #3		34
S-DD PPTH 3		35
S-DD PPCH 3		36
S-DD TPCH #3 Z		37
S-MD HWH #2		38
S-MD 10 HWH #3		39
S-MD 12 HWH #3		40
S-MD 12 HWH #4		41
S-MD 12 HWH #5		42
S-MD HHWH STITCH/PILOT		43
S-MD 1/4-14 HHWH #3		44



Wood boards to metal substructure

Description	Screw	Page
S-WD PFH #3		45
S-WD PWH #3		46
S-WW PWH #3		47
S-WW PWH #4		48
SFH SD		49
SFH SD ZINC		50
SFH S		51

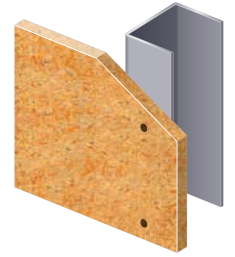

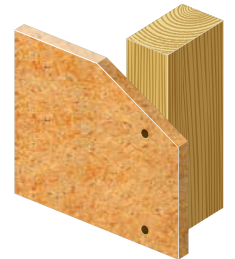

Wood boards to wood substructure

Description	Screw	Page
PBH S CRS Kaitex		22



Eye lag screws to wood or metal substructure

Description	Screw	Page
EL WS		52
EL S		52
EL SD		52

2. FEATURES OF INTERIOR FINISHING SCREWS

Head shapes

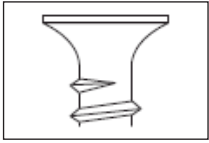

PBH

Phillips Bugle Head: used primarily for fastening drywall, plywood or insulation because it countersinks well

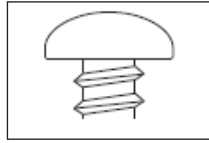

PPH

Phillips Pan Head: conventional head for general applications that provides low profile fastening

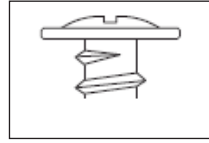

PTH

Phillips Truss Head: Large head and low profile used primarily for framing and attaching wire lath

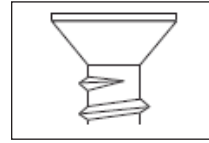

PFH

Phillips Flat Head: used primarily in wood to countersink and seat flush to minimize splintering the wood

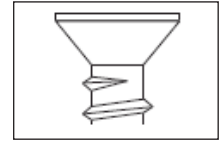

SFH

Square Flat Head: used primarily in wood to countersink and seat flush to minimize splintering the wood



PPCH

Phillips Pancake Head: conventional head for general applications that provides low and flat profile

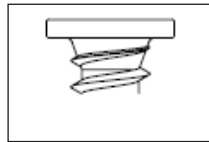

TPCH

Torx Pancake Head: conventional head for high torque applications that provides low and flat profile

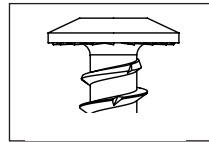

PFTH

Phillips Flat Truss Head: lowest profile available for attaching metal to metal

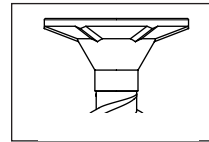

PWH

Phillips Wafer Head: Large head provides the bearing surface necessary to seat flush in soft materials

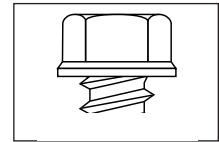

HWH/HHWH

Hex Washer Head/ High Hex Washer Head Washer heads provides a bearing surface for the driving sockets

Insert bit type

Standard drive recesses for most drywall screws

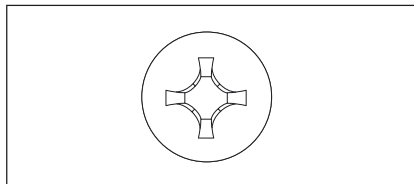

Phillips cross recess (PH)

Head drive recess for tapping screws and wood screws

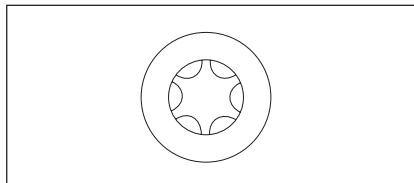

Torx (TX)

Square head for selected screws for fastening wood boards

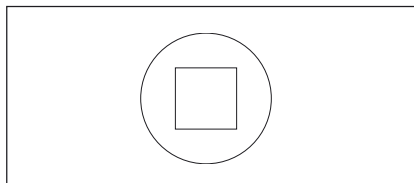

Square (SQ)

Square head for selected exterior framing screws

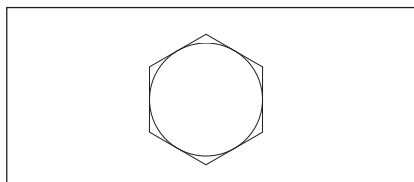

Hexagon head (HEX)

Drill Point / Drilling Capacity

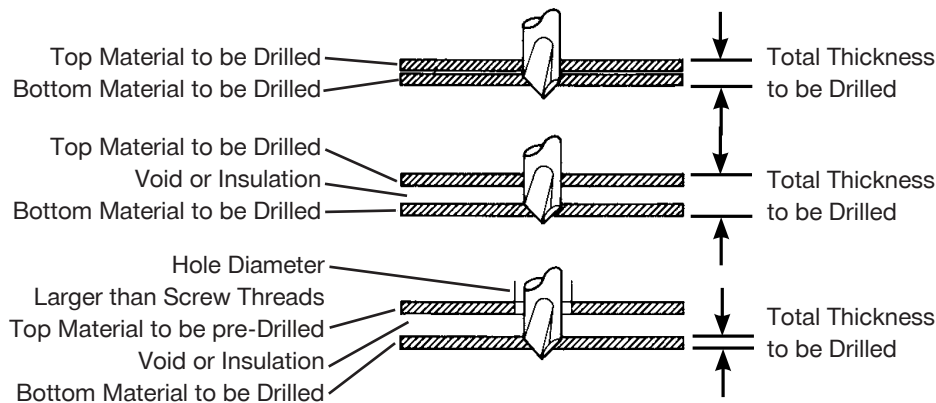

Self Drilling Screw capacity by point and diameter

Thickness of Material to be Drilled (inches)	#2 Point		#3 Point			#4 Point			#5 Point	
	.500									
.400										
.300										
.200				.175	.210	.220	.232	.250	.250	
.100	.100	.110	.140							
0.035										
0	#6, #8	#10	#8	#10	#12	1/4	#12 Winged Reamer	*#12	1/4	#12

Length Selection

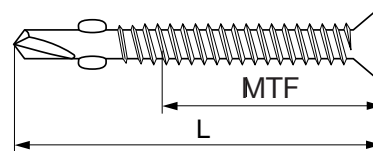
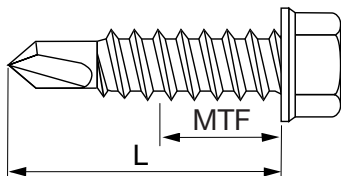

Length of the screw (L)

Depending on the screwhead, there are two different ways to measure the overall length of a screw.

For HWH/HHWH, SHWH, PPCH, PFTH, PTH and PPH screws, the overall length is measured from the bottom of the collar under the head to the point of the screw.

For PWH, PFH, PFHUC and PBH screws, the overall length is measured from the top of the head to the point of the screw.

Maximum Thickness Fastened (MTF)

The maximum thickness fastened for all screws is the length of the threads reduced by the first three threads (embedment in the base material). See drawings above.

The maximum thickness fastened (MTF) describes the maximum thickness of the attachments to be secured to the base material.

Thread selection

Recommended Installation RPM

Diameter	RPM
#6	4000-5000
#8	2500
#10	
#12	1800
1/4"	

Common Socket and Bit Sizes

Screw Size	Magnetic Nut Setter Size	Phillips Bit Size
#6	-	2
#8	1/4"	2
#10	5/16"	3
#12	5/16"	3
1/4"	3/8"	3

Decimal Equivalents for Fractions of an Inch

Fraction	Decimal Equivalent
1/64	0.015
1/32	0.031
3/64	0.046
1/16	0.062
5/64	0.078
3/32	0.093
7/64	0.109
1/8	0.125
9/64	0.140
5/32	0.156
11/64	0.171
3/16	0.187
13/64	0.203
7/32	0.218
15/64	0.234
1/4	0.250
5/16	0.313

Screw Diameter Equivalents

Screw Diameter	Decimal Equivalent	mm
#6	0.138	3.5
#7	0.151	3.9
#8	0.164	4.2
#10	0.190	4.8
#12	0.216	5.5
#14	0.242	6.3
1/4"	0.250	6.4

Gauge to Inches and Millimeters Conversion

Gauge (ga)	Mils	Inches (in)		Millimeters (mm)	
		Aluminum	Sheet Metal	Aluminum	Sheet Metal
12	97	0.0809	0.1046	2.053	2.656
14	68	0.0641	0.0747	1.628	1.897
16	54	0.0508	0.0598	1.290	1.519
18	43	0.0403	0.0478	1.024	1.214
20	33	0.0320	0.0359	0.813	0.912
22	27	0.0253	0.0299	0.643	0.759
25	18	0.0179	0.0209	0.455	0.531

Inches to Millimeters Conversion

Inches (in)	Millimeters (mm)
1/32"	0.79 mm
1/16"	1.57 mm
1/8"	3.18 mm
3/16"	4.78 mm
1/4"	6.35 mm
5/16"	7.95 mm
3/8"	9.53 mm
7/16"	11.13 mm
1/2"	12.70 mm
9/16"	14.30 mm
5/8"	15.88 mm
11/16"	17.48 mm
3/4"	19.05 mm
13/16"	20.65 mm
7/8"	22.23 mm
15/16"	23.83 mm
1"	25.4 mm
1-1/8"	28.58 mm
1-1/4"	31.75 mm
1-5/8"	41.28 mm
2"	50.8 mm
3"	76.2 mm

3. ENVIRONMENT CATEGORIES

Applications can be classified in various environment categories, taking the following main factors into account:

Indoor applications



Dry indoor environments

(heated or air-conditioned areas) without condensation, e.g. office buildings, schools



Indoor environments with temporary condensation

(unheated areas without pollutants), e.g. storage sheds

Outdoor applications



Outdoor, rural or urban environment with low pollution

Large distance (> 6 miles [10 km]) from the sea



Outdoor, rural or urban environment with moderate concentration of pollutants and/or salt from sea water

Distance from the sea 0.6-6 miles [1-10 km]



Coastal areas

Distance from the sea < 0.6 miles [1 km]



Outdoor, areas with heavy industrial pollution

Close to plants < 0.6 miles [1 km] (e.g. petrochemical, coal industry)



Close proximity to roadways treated with de-icing salts

Distance from roadways < 33 feet [10 meters]

Special applications



Special applications

Areas with special corrosive conditions, e.g. road tunnels with de-icing salt, indoor swimming pools, special applications in the chemical industry (exceptions possible).



Important notes

The ultimate decision on the required corrosion protection must be made by the customer. Hilti accepts no responsibility regarding the suitability of a product for a specific application, even if informed of the application conditions.

The tables are based on an average service life for typical applications. For metallic coatings, e.g. zinc layer systems, the end of lifetime is the point at which red rust is visible over a large fraction of the product and widespread structural deterioration can occur – the initial onset of rust may occur sooner. National or international codes, standards or regulations, customer and/or industry specific guidelines must be independently considered and evaluated.

These guidelines apply to atmospheric corrosion only. Special types of corrosion, such as crevice corrosion or hydrogen assisted cracking must be independently evaluated.

The tables published in this brochure describe only a general guideline for commonly accepted applications in typical atmospheric environments. Suitability for a specific application can be significantly affected by localized conditions, including but not limited to:

- Elevated temperatures and humidity
- High levels of airborne pollutants
- Direct contact with corrosive products, such as found in some types of chemically-treated wood, waste water, concrete additives, cleaning agents, etc.
- Direct contact to fresh / young concrete (less than 28 days old)
- Electrical current
- Contact with dissimilar metals
- Confined areas, e.g. crevices
- Physical damage or wear
- Extreme corrosion due to combined effects of different influencing factors
- Enrichment of pollutants on the product

ENVIRONMENT CATEGORIES

The following tables provides a general guideline for the most common screw fastening applications. The appropriate corrosion protection for each fastening material is shown based on the typical atmospheric environments (see notes).

	Screws	PBH S PPH S	PBH SD ZINC PTH S ZINC PBH S ZINC	PBH S CRS KCOTE PBH S CRS KAITEX	PBH SD CRC PWH SD CMT
	Coating/Material	Phosphated carbon steel	Galvanic zinc plated carbon steel	Kwik-coat or kaitex coated carbon steel	Electro- or Kaitex Duplex coated carbon steel
Environmental conditions	Fastened part				
Dry indoor	Steel (zinc-coated, painted), aluminium, stainless steel	■	■	■	■
Indoor with temporary condensation	Steel (zinc-coated, painted), aluminium, stainless steel	—	—	■	■
Outdoor with low pollution	Steel (zinc-coated, painted), aluminium, stainless steel	—	—	—	□ ²⁾
Outdoor with moderate concentration of pollutants 1-10km	Steel (zinc-coated, painted), aluminium, stainless steel	—	—	—	□ ²⁾
Coastal areas 0-1km	Steel (zinc-coated, painted), aluminium, stainless steel	—	—	—	—
Outdoor, areas with heavy industrial pollution	Steel (zinc-coated, painted), aluminium, stainless steel	—	—	—	—
Close proximity to roads	Steel (zinc-coated, painted), aluminium, stainless steel	—	—	—	—
Special applications	Steel (zinc-coated, painted), aluminium, stainless steel	—	—	—	—

- = expected lifetime of fasteners made from this material is typically satisfactory in the specified environment based on the typically expected lifetime of a building. The assumed service life in ETA approvals for screw fasteners is 25 years.
- ²⁾ = a decrease in the expected lifetime of non-stainless fasteners in these atmospheres must be taken into account (≤ 25 years). Higher expected lifetime needs a specific assessment.
- = fasteners made from this material are not generally suitable in the specified environment. Exceptions need a specific assessment.

Corrosion resistance overview

Coating	Example of screws	Typical ASTM B117 Salt spray rating (in hours)	Typical conditions of use
Phosphated	PBH S	24	- Interior applications without any particular influence of moisture
Zinc plated	PBH SD ZINC	24 - 48	
Kwik cote	PBH S CRS KCOTE	500	- Interior applications which are in damp environments
Kaitex	PBH S CRS KAITEX	500	
Electro coating	PBH SD CRC	1000	- Interior applications which are in damp environments - Exterior applications in only slightly corrosive atmosphere
Kaitex duplex coating	PWH SD CMT	1000	

4. SCREW PAGES

PBH S

Application:

Drywall boards to metal substructure 25 ga to 20 ga

Technical data:

Screw design	Stitch point - Fine thread - Bugle head
Insert bit type	PH2
Material	Carbon steel
Coating	Phosphated
Approval	ICC-ES_ESR-3891 / ASTM C1002*
Environmental conditions	

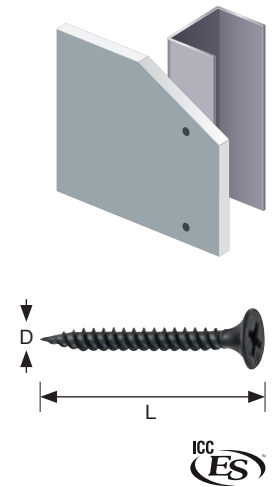

* Meets or exceeds ASTM C1002 performance requirements

Single screws

Description	Length L [in]	Diameter D [ga]	Drilling capacity [ga]	Drilling capacity [in]	Max. Thickness Fastened (MTF)	Head diameter [in]	Pkg. quantity	Item no.
6x1 PBH S	1	6	25 - 20	0.023 - 0.036	5/8" (0.625")	0.32	10000	84297
6x1-1/8 PBH S	1-1/8	6	25 - 20	0.023 - 0.036	3/4" (0.750")	0.32	10000	84329
6x1-1/4 PBH S	1-1/4	6	25 - 20	0.023 - 0.036	7/8" (0.875")	0.32	8000	84291
6x1-5/8 PBH S	1-5/8	6	25 - 20	0.023 - 0.036	1-1/4" (1.250")	0.32	5000	84323
6x2 PBH S	2	6	25 - 20	0.023 - 0.036	1-5/8" (1.625")	0.32	3500	84310
6x2-1/4 PBH S	2-1/4	6	25 - 20	0.023 - 0.036	1-7/8" (1.875")	0.32	3000	84311
7x2-1/2 PBH S	2-1/2	7	25 - 20	0.023 - 0.036	2-1/8" (2.125")	0.32	2500	84319
8x3 PBH S	3	8	25 - 20	0.023 - 0.036	2-5/8" (2.625")	0.33	2000	84328

Collated screws for SD-M 1 and SD-M 2

Description	Length L [in]	Diameter D [ga]	Drilling capacity [ga]	Drilling capacity [in]	Head diameter [in]	Pkg. quantity	SD-M 1	SD-M 2	Item no.
6x1 PBH S M1	1	6	25 - 20	0.023 - 0.036	0.32	10000	■	■	2086227
6x1-1/8 PBH S M1	1-1/8	6	25 - 20	0.023 - 0.036	0.32	10000	■	■	2070966
6x1-1/4 PBH S M1	1-1/4	6	25 - 20	0.023 - 0.036	0.32	8000	■	■	2070967
6x1-1/4 PBH S M1 L*	1-1/4	6	25 - 20	0.023 - 0.036	0.32	8000	■	■	2232819
6x1-5/8" PBH S M1	1-5/8	6	25 - 20	0.023 - 0.036	0.32	5000		■	2131083
6x2 PBH S M1	2	6	25 - 20	0.023 - 0.036	0.32	4000		■	2131084

*40 screw strip

PBH S ZINC

Application:

Drywall boards to metal substructure 25 ga to 20 ga

Technical data:

Screw design	Stitch point - Fine thread - Bugle head
Insert bit type	PH2
Material	Carbon steel
Coating	Zinc plated
Approval	ICC-ES_ESR-3891 / ASTM C1002*
Environmental conditions	

* Meets or exceeds ASTM C1002 performance requirements

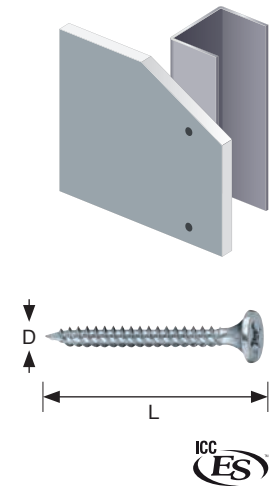

Single screws

Description	Length L [in]	Diameter D [ga]	Drilling capacity [ga]	Drilling capacity [in]	Max. Thickness Fastened (MTF)	Head diameter [in]	Pkg. quantity	Item no.
6x1 PBH S ZINC	1	6	25 - 20	0.023 - 0.036	5/8" (0.625")	0.32	10000	2276739
6x1-1/8 PBH S ZINC	1-1/8	6	25 - 20	0.023 - 0.036	3/4" (0.750")	0.32	10000	2276921

Collated screws for SD-M 1 and SD-M 2

Description	Length L [in]	Diameter D [ga]	Drilling capacity [ga]	Drilling capacity [in]	Head diameter [in]	Pkg. quantity	SD-M 1	SD-M 2	Item no.
6x1 PBH S Z M1	1	6	25 - 20	0.023 - 0.036	0.32	10000	■	■	2276920
6x1-1/8 PBH S Z M1	1-1/8	6	25 - 20	0.023 - 0.036	0.32	10000	■	■	2276737

PBH SD

Application:

Drywall boards to metal substructure from 20 ga to 12 ga
 Hard boards to metal substructure from 20 ga 12 ga

Technical data:

Screw design	Drill point - Fine thread - Bugle head
Insert bit type	PH2
Material	Carbon steel
Coating	Phosphated
Approval	ICC-ES_ESR-3891 / ASTM C954*
Environmental conditions	

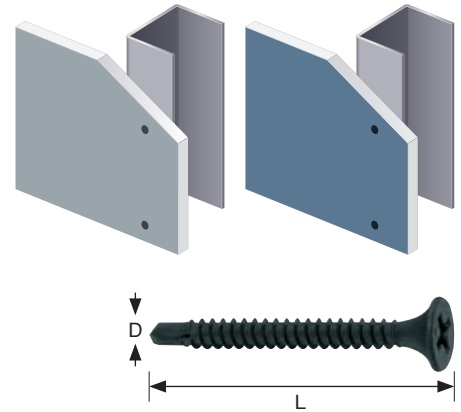

* Meets or exceeds ASTM C954 performance requirements

Single screws

Description	Length L [in]	Diameter D [ga]	Drilling capacity [ga]	Drilling capacity [in]	Max. Thickness Fastened (MTF)	Head diameter [in]	Pkg. quantity	Item no.
6x1 PBH SD	1	6	20 - 12	0.033 - 0.088	5/8" (0.625")	0.32	10000	86211
6x1-1/8 PBH SD	1-1/8	6	20 - 12	0.033 - 0.088	3/4" (0.750")	0.32	10000	86213
6x1-1/4 PBH SD	1-1/4	6	20 - 12	0.033 - 0.088	7/8" (0.875")	0.32	8000	84290
6x1-5/8 PBH SD	1-5/8	6	20 - 12	0.033 - 0.088	1-1/4" (1.250")	0.32	5000	86216
6x1-7/8 PBH SD	1-7/8	6	20 - 12	0.033 - 0.088	1-1/2" (1.500")	0.32	4000	86218
8x2-3/8 PBH SD	2-3/8	8	20 - 12	0.033 - 0.112	2" (2.000")	0.32	2500	86220
8x2-5/8 PBH SD	2-5/8	8	20 - 12	0.033 - 0.112	2-1/4" (2.250")	0.32	1600	84293
8x3 PBH SD	3	8	20 - 12	0.033 - 0.112	2-5/8" (2.625")	0.33	1400	86223

Collated screws for SD-M 1 and SD-M 2

Description	Length L [in]	Diameter D [ga]	Drilling capacity [ga]	Drilling capacity [in]	Head diameter [in]	Pkg. quantity	SD-M 1	SD-M 2	Item no.
6x1-1/8 PBH SD M1	1-1/8	6	20 - 12	0.033 - 0.088	0.32	10000	■	■	2070962
6x1-1/4 PBH SD M1	1-1/4	6	20 - 12	0.033 - 0.088	0.32	8000	■	■	2070963
6x1-1/4 PBH SD M1 L*	1-1/4	6	20 - 12	0.033 - 0.088	0.32	8000	■	■	2232901
6x1-5/8 PBH SD M1	1-5/8	6	20 - 12	0.033 - 0.088	0.32	5000		■	2132338
6x1-7/8 PBH SD M1	1-7/8	6	20 - 12	0.033 - 0.088	0.32	4000		■	2132339
6x2 PBH SD M1	2	6	20 - 12	0.033 - 0.088	0.32	4000		■	2133710

*40 screw strip

PBH SD ZINC

Application:

Drywall boards to metal substructure from 20 ga to 12 ga

Hard boards to metal substructure from 20 ga 12 ga

Technical data:

Screw design	Drill point - Fine thread - Bugle head
Insert bit type	PH2
Material	Carbon steel
Coating	Zinc plated
Approval	ICC-ES-ESR-3891 / ASTM C954*
Environmental conditions	

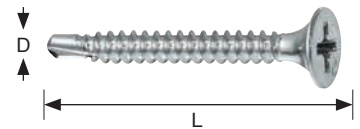
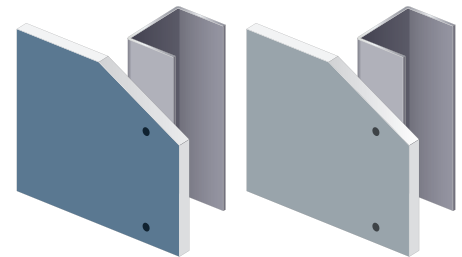

* Meets or exceeds ASTM C954 performance requirements

Single screws

Description	Length L [in]	Diameter D [ga]	Drilling capacity [ga]	Drilling capacity [in]	Max. Thickness Fastened (MTF)	Head diameter [in]	Pkg. quantity	Item no.
6x1 PBH SD ZINC	1	6	20 -12	0.033 - 0.088	5/8" (0.625")	0.32	10000	86212
6x1-1/8 PBH SD ZINC	1-1/8	6	20 -12	0.033 - 0.088	3/4" (0.750")	0.32	10000	86214
6x1-1/4 PBH SD ZINC	1-1/4	6	20 -12	0.033 - 0.088	7/8" (0.875")	0.32	8000	86215
6x1-5/8 PBH SD ZINC	1-5/8	6	20 -12	0.033 - 0.088	1-1/4" (1.250")	0.32	5000	86217
6x1-7/8 PBH SD ZINC	1-7/8	6	20 -12	0.033 - 0.088	1-1/2" (1.500")	0.32	4000	86219
8x2-3/8 PBH SD ZINC	2-3/8	8	20 -12	0.033 - 0.112	2" (2.000")	0.32	2500	86221
8x2-5/8 PBH SD ZINC	2-5/8	8	20 -12	0.033 - 0.112	2-1/4" (2.250")	0.32	1600	86222
8x3 PBH SD ZINC	3	8	20 -12	0.033 - 0.112	2-5/8" (2.625")	0.33	1400	86224

Collated screws for SD-M 1 and SD-M 2

Description	Length L [in]	Diameter D [ga]	Drilling capacity [ga]	Drilling capacity [in]	Head diameter [in]	Pkg. quantity	SD-M 1	SD-M 2	Item no.
6x1-1/8 PBH SD Z M1	1-1/8	6	20 -12	0.033 - 0.088	0.32	10000	■	■	2070964
6x1-1/4 PBH SD Z M1	1-1/4	6	20 -12	0.033 - 0.088	0.32	8000	■	■	2070965
6x1-1/4 PBH SD Z M1 L*	1-1/4	6	20 -12	0.033 - 0.088	0.32	1000	■	■	2232902
6x1-5/8 PBH SD Z M1	1-5/8	6	20 -12	0.033 - 0.088	0.32	5000		■	2133711
6x1-7/8 PBH SD Z M1	1-7/8	6	20 -12	0.033 - 0.088	0.32	4000		■	2133712
6x2 PBH SD Z M1	2	6	20 -12	0.033 - 0.088	0.32	4000		■	2131085

*40 screw strip

PBH SD CRC

Application:

Drywall boards to metal substructure from 20 to 14 ga

Hard boards to metal substructure from 20 ga to 14 ga

Exterior sheathing boards to metal substructure from 20 ga to 14 ga

Technical data:

Screw design	Drill point - Fine thread - Bugle head
Insert bit type	PH2
Material	Carbon steel
Coating	Electro-Coating
Approval	ICC-ES_ ESR-3891 / ASTM C954*
Environmental conditions	

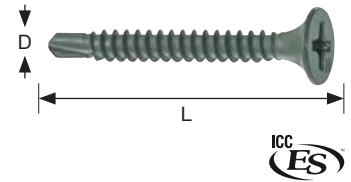
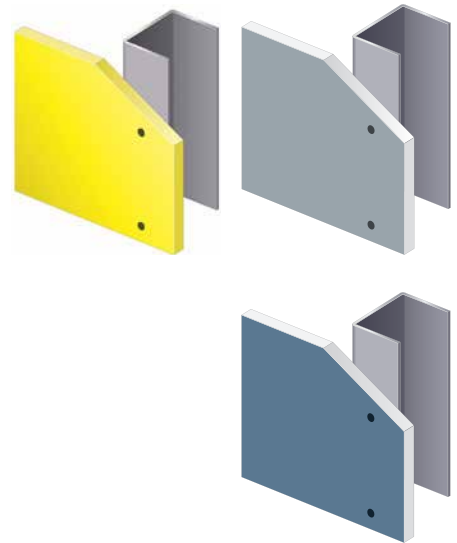

* Meets or exceeds ASTM C954 performance requirements

Single screws

Description	Length L [in]	Diameter D [ga]	Drilling capacity [ga]	Drilling capacity [in]	Max. Thickness Fastened (MTF)	Head diameter [in]	Pkg. quantity	Item no.
6x1-1/4 PBH SD CRC	1-1/4	6	20 -14	0.033 - 0.088	7/8" (0.875")	0.32	8000	411517
6x1-7/8 PBH SD CRC	1-7/8	6	20 -14	0.033 - 0.088	1-1/2" (1.500")	0.32	4000	413489

Collated screws for SD-M 1 and SD-M 2

Description	Length L [in]	Diameter D [ga]	Drilling capacity [ga]	Drilling capacity [in]	Head diameter [in]	Pkg. quantity	SD-M 1	SD-M 2	Item no.
6x1-1/4 PBH SD CRC M1	1-1/4	6	20 -14	0.033 - 0.088	0.32	8000	■	■	2071040
6x1-7/8 PBH SD CRC M1	1-7/8	6	20 -14	0.033 - 0.088	0.32	4000		■	2133713

PBH S HI/LO

Application:

Drywall boards to metal substructure from 25 ga to 20 ga
 Drywall boards to wood substructure

Technical data:

Screw design	Stich point - Hi/Lo thread - Bugle head
Insert bit type	PH2
Material	Carbon steel
Coating	Phosphated
Approval	ASTM 1002*
Environmental conditions	

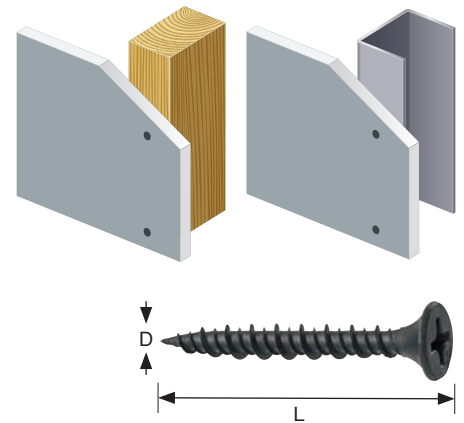

* Meets or exceeds ASTM C954 performance requirements

Single screws

Description	Length L [in]	Diameter D [ga]	Drilling capacity [ga]	Drilling capacity [in]	Head diameter [in]	Pkg. quantity	Item no.
6x1-1/8 PBH S HI/LO	1-1/8	6	25 - 20	0.023 - 0.033	0.32	10000	86198
6x1-1/4 PBH S HI/LO	1-1/4	6	25 - 20	0.023 - 0.033	0.32	8000	86199
6x1-5/8 PBH S HI/LO	1-5/8	6	25 - 20	0.023 - 0.033	0.32	5000	86200
6x2 PBH S HI/LO	2	6	25 - 20	0.023 - 0.033	0.32	3500	86201
8x3 PBH S HI/LO	3	8	25 - 20	0.023 - 0.033	0.32	2000	86204

Collated screws for SD-M 1 and SD-M 2

Description	Length L [in]	Diameter D [ga]	Drilling capacity [ga]	Drilling capacity [in]	Head diameter [in]	Pkg. quantity	SD-M 1	SD-M 2	Item no.
6x1-1/8 PBH S HI/LO M1	1-1/8	6	25 - 20	0.023 - 0.033	0.32	10000	■	■	2133716
6x1-1/4 PBH S HI/LO M1	1-1/4	6	25 - 20	0.023 - 0.033	0.32	8000	■	■	2133717
6x1-5/8 PBH S HI/LO M1	1-5/8	6	25 - 20	0.023 - 0.033	0.32	5000		■	2133718
6x2 PBH S HI/LO M1	2	6	25 - 20	0.023 - 0.033	0.32	4000		■	2133719

PBH S CRS

Application:
Drywall boards to wood substructure

Technical data:

Screw design $\leq 2''$	Stitch point - Coarse thread - Bugle head
Screw design $\geq 2-1/4''$	Stitch point - Shank - Coarse thread - Bugle head
Insert bit type	PH2
Material	Carbon steel
Coating	Phosphated
Approval	-
Environmental conditions	

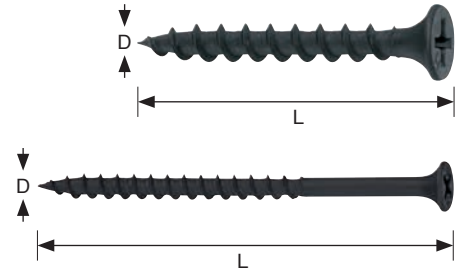
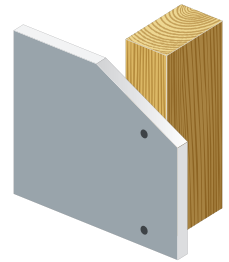

Single screws

Description	Length L [in]	Diameter D [ga]	Head diameter [in]	Pkg. quantity	Item no.
6x1 PBH S CRS	1	6	0.32	10000	84325
6x1-1/8 PBH S CRS	1-1/8	6	0.32	10000	84316
6x1-1/4 PBH S CRS	1-1/4	6	0.32	8000	84294
6x1-5/8 PBH S CRS	1-5/8	6	0.32	5000	84307
7x2 PBH S CRS	2	7	0.32	3500	84320
7x2-1/4 PBH S CRS	2-1/4	7	0.32	3000	84295
7x2-1/2 PBH S CRS	2-1/2	7	0.32	2500	84322
8x3 PBH S CRS	3	8	0.32	2000	84317

Collated screws for SD-M 1 and SD-M 2



Description	Length L [in]	Diameter D [ga]	Head diameter [in]	Pkg. quantity	SD-M 1	SD-M 2	Item no.
6x1-1/8 PBH S CRS M1	1-1/8	6	0.32	10000	■	■	2070968
6x1-1/4 PBH S CRS M1	1-1/4	6	0.32	8000	■	■	2070969
6x1-1/4 PBH S CRS M1 L*	1-1/4	6	0.32	8000	■	■	2232900
6x1-5/8 PBH S CRS M1	1-5/8	6	0.32	5000		■	2133714
6x2 PBH S CRS M1	2	6	0.32	4000		■	2131086

*40 screw strip

PBH S CRS KCOTE

Application:
Drywall boards to wood substructure

Technical data:

Screw design	Stitch point - Coarse thread - Bugle head
Insert bit type	PH2
Material	Carbon steel
Coating	Kwik cote
Approval	-
Environmental conditions	 

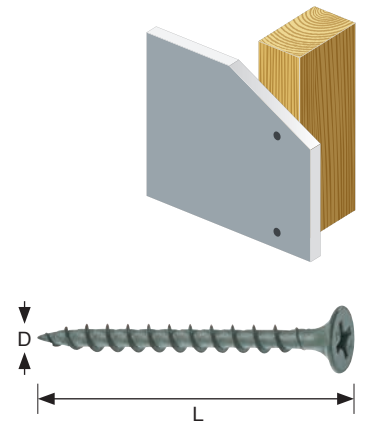



Collated screws for SD-M 1 and SD-M 2

Description	Length L [in]	Diameter D [ga]	Head diameter [in]	Pkg. quantity	SD-M 1	SD-M 2	Item no.
6x2 PBH S CRS KCOTE M1	2	6	0.32	1000		■	2133715

PBH S CRS KAITEX

Application:
Wood to wood substructure

Technical data:

Screw design $\leq 2''$	Stitch point - Coarse thread - Bugle head
Screw design $\geq 2-1/4''$	Stitch point - Shank - Coarse thread - Bugle head
Insert bit type	PH2
Material	Carbon steel
Coating	Kaitex coated
Approval	-
Environmental conditions	 

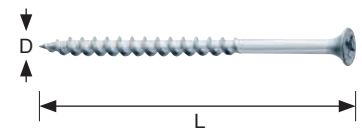
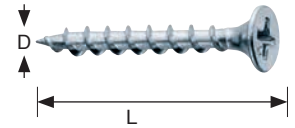
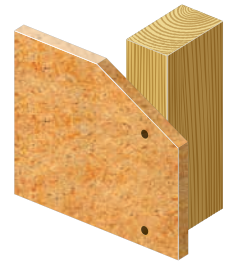

Single screws

Description	Length L [in]	Diameter D [ga]	Head diameter [in]	Pkg. quantity	Item no.
6x1-1/4" PBH S CRS	1-1/4"	6	0.32	8000	10196
6x2" PBH S CRS	2"	6	0.32	3500	10215
8x2-1/2" PBH S CRS	2-1/2"	7	0.32	2500	10222
8x3" PBH S CRS	3"	8	0.32	2000	10224

PBH S LAM

Application:
Drywall boards to drywall boards

Technical data:

Screw design	Stitch point - Coarse thread - Bugle head
Insert bit type	PH2
Material	Carbon steel
Coating	Phosphated
Approval	-
Environmental conditions	

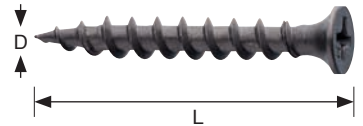
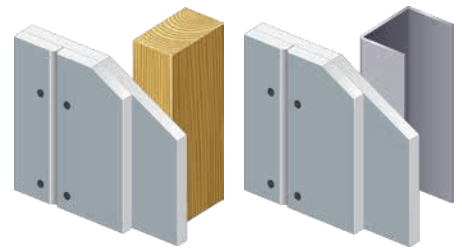

Single screws

Description	Length L [in]	Diameter D [ga]	Head diameter [in]	Pkg. quantity	Item no.
10x1-1/2 PBH S LAM	1-1/2	10	0.32	5000	86205

PWH S CMT BD

Application:

Cement boards to metal substructure from 25 ga to 20 ga

Cement boards to wood substructure

Exterior sheathing boards to metal substructure from 25 ga to 20 ga

Technical data:

Screw design	Drill point - Hi/Lo thread - Wafer head
Insert bit type	PH2
Material	Carbon steel
Coating	Kaitex Duplex-Coated
Approval	ASTM C1002*
Environmental conditions	

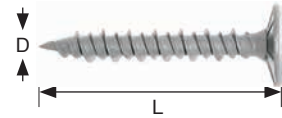

* Meets or exceeds ASTM C1002 performance requirements

Single screws

Description	Length L [in]	Diameter D [ga]	Drilling capacity [ga]	Drilling capacity [in]	Head diameter [in]	Pkg. quantity	Item no.
8x1-1/4 PWH S CMT BD	1-1/4	8	25 - 20	0.023 - 0.036	0.42	5000	372757
9x1-5/8 PHL S CMT BD	1-5/8	9	25 - 20	0.023 - 0.036	0.42	4000	3024068
9x2-1/4 PW S Hi-Lo CMT BD	2-1/4	9	25 - 20	0.023 - 0.036	0.42	2000	3024069

PWH SD CMT BD

Application:

Cement boards to metal substructure from 20 ga to 12 ga
 Exterior sheathing boards to metal substructure from 20 ga to 12 ga

Technical data:

Screw design	Drill point - Hi/Lo thread - Wafer head
Insert bit type	PH2
Material	Carbon steel
Coating	Kaitex Duplex-Coated
Approval	ICC-ES-ESR-3891 / ASTM C954*
Environmental conditions	

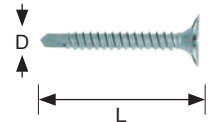

* Meets or exceeds ASTM C954 performance requirements

Single screws

Description	Length L [in]	Diameter D [ga]	Drilling capacity [ga]	Drilling capacity [in]	Max. Thickness Fastened (MTF)	Head diameter [in]	Pkg. quantity	Item no.
8x1-1/4 PWH SD CMT BD	1-1/4	8	20 -12	0.033 - 0.112	7/8" (0.875")	0.42	5000	372759
8x1-5/8 PWH SD CMT BD	1-5/8	8	20 -12	0.033 - 0.112	1-1/4" (1.250")	0.42	4000	372760

PTH S LATH

Application:

Fastening wire lath to 25 - 20 ga studs

Fastening stud to track from 25 ga to 20 ga

Technical data:

Screw design Stitch point - Fine thread - Truss head

Insert bit type PH2

Material Carbon steel

Coating Phosphated

Approval -

Environmental conditions

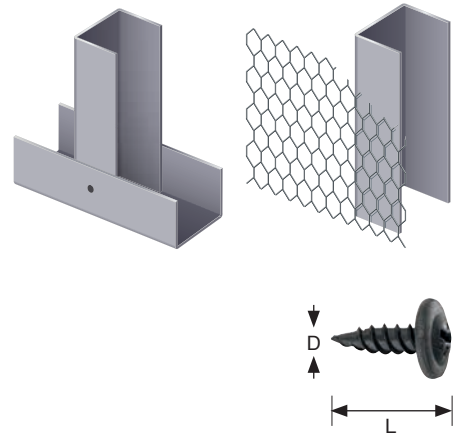

Single screws

Description	Length L [in]	Diameter D [ga]	Drilling capacity [ga]	Drilling capacity [in]	Max. Thickness Fastened (MTF)	Head diameter [in]	Pkg. quantity	Item no.
8x1/2 PTH S	1/2	8	25 - 20	0.023 - 0.033	1/8" (0.125")	0.43	10000	86208

PTH S LATH ZINC

Application:

Fastening wire lath to 25 - 20 ga studs

Fastening stud to track from 25 ga to 20 ga

Technical data:

Screw design	Stitch point - Fine thread - Wafer head
Insert bit type	PH2
Material	Carbon steel
Coating	Zinc plated
Standard	-
Environmental conditions	

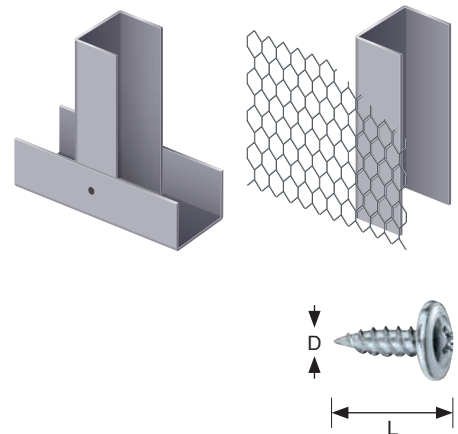

Single screws

Description	Length L [in]	Diameter D [ga]	Drilling capacity [ga]	Drilling capacity [in]	Max. Thickness Fastened (MTF)	Head diameter [in]	Pkg. quantity	Item no.
8x1/2 PTH S LATH ZINC	1/2	8	25 - 20	0.023 - 0.033	1/8" (0.125")	0.43	10000	10262
8x3/4 PTH S LATH ZINC	3/4	8	25 - 20	0.023 - 0.033	3/8" (0.375")	0.43	10000	10263
8x1 PTH S LATH ZINC	1	8	25 - 20	0.023 - 0.033	5/8" (0.625")	0.43	8000	10264
8x1-1/4 PTH S LATH ZINC	1-1/4	8	25 - 20	0.023 - 0.033	7/8" (0.875")	0.43	6000	10265

PTH SD LATH ZINC

Application:

Fastening wire lath to 20 - 12 ga studs

Fastening stud to track from 20 ga to 12 ga

Technical data:

Screw design Drill point - Fine thread - Truss head

Insert bit type PH2

Material Carbon steel

Coating Zinc plated

Approval ICC-ES-ESR-2196 / ASTM C1513*

Environmental conditions

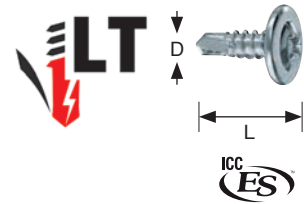
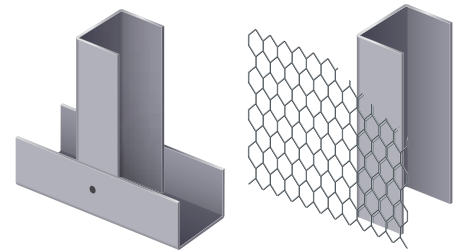

* Meets or exceeds ASTM C1513 performance requirements

Single screws

Description	Length L [in]	Diameter D [ga]	Drilling capacity [ga]	Drilling capacity [in]	Max. Thickness Fastened (MTF)	Head diameter [in]	Pkg. quantity	Item no.
8x1/2 PTH SD LATH ZINC	1/2	8	20 - 12	0.036 - 0.104	1/8" (0.125")	0.43	10000	2297632
8x3/4 PTH SD LATH ZINC	3/4	8	20 - 12	0.036 - 0.104	3/8" (0.375")	0.43	6000	2297633
8x1 PTH SD LATH ZINC	1	8	20 - 12	0.036 - 0.104	5/8" (0.625")	0.43	10000	2297634
8x1-1/4 PTH SD LATH ZINC	1-1/4	8	20 - 12	0.036 - 0.104	7/8" (0.875")	0.43	8000	2297637
8x1-5/8 PTH SD LATH ZINC	1-5/8	8	20 - 12	0.036 - 0.104	1-1/4" (1.250")	0.43	4000	2297638
8x1-7/8 PTH SD LATH ZINC	1-7/8	8	20 - 12	0.036 - 0.104	1-1/2" (1.500")	0.43	3000	2297639

PPH S

Application:

Fastening stud to track from 25 ga to 20 ga

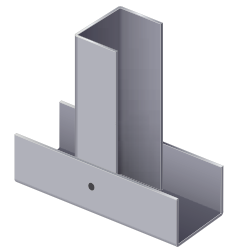

Technical data:

Screw design	Stitch point - Fine thread - Pan head
Insert bit type	PH2
Material	Carbon steel
Coating	Phosphated
Approval	-
Environmental conditions	

Single screws

Description	Length L [in]	Diameter D [ga]	Drilling capacity [ga]	Drilling capacity [in]	Max. Thickness Fastened (MTF)	Head diameter [in]	Pkg. quantity	Item no.
6x7/16 PPH S	7/16	6	25 - 20	0.023 - 0.036	1/16" (0.0625")	0.30	10000	86207
7x7/16 PPH S	7/16	7	25 - 20	0.023 - 0.036	1/16" (0.0625")	0.30	10000	86206

PPH SD FRMR

Application:

Fastening stud to track from 20 ga to 12 ga

Technical data:

Screw design	Drill point - Fine thread - Pan head
Insert bit type	PH2
Material	Carbon steel
Coating	Phosphated
Approval	ICC-ES-ESR-2196 / ASTM C1513*
Environmental conditions	

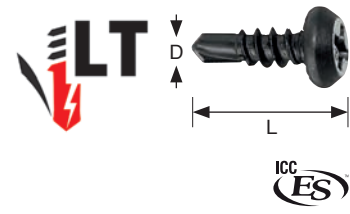
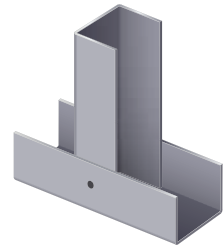

* Meets or exceeds ASTM C1513 performance requirements

Single screws

Description	Length L [in]	Diameter D [ga]	Drilling capacity [ga]	Drilling capacity [in]	Max. Thickness Fastened (MTF)	Head diameter [in]	Pkg. quantity	Item no.
7x7/16 PPH SD FRMR	7/16	7	20 -12	0.036 - 0.104	1/16" (0.0625")	0.30	10000	2297630

PPH SD FRMR ZINC

Application:

Fastening stud to track from 20 ga to 12 ga

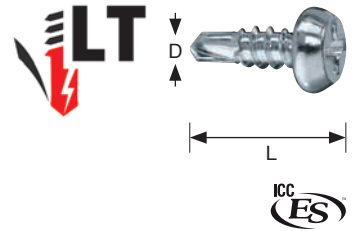
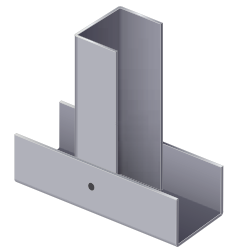

Technical data:

Screw design	Drill point - Fine thread - Pan head
Insert bit type	PH2
Material	Carbon steel
Coating	Zinc plated
Approval	ICC-ES-ESR-2196 / ASTM C1513*
Environmental conditions	

* Meets or exceeds ASTM C1513 performance requirements

Single screws

Description	Length L [in]	Diameter D [ga]	Drilling capacity [ga]	Drilling capacity [in]	Max. Thickness Fastened (MTF)	Head diameter [in]	Pkg. quantity	Item no.
7x7/16 PPH SD FRMR ZINC	7/16	7	20 -12	0.036 - 0.104	1/16" (0.0625")	0.30	10000	2297631

S-MD PPH #2

Application:

Light gauge steel to steel applications

HVAC duct fabrication and installation

Accessories (electrical boxes, clips, etc.) to steel

Technical data:

Screw design	Drill point - Fine thread - Pan head
Insert bit type	PH2
Material	Carbon steel
Coating	Zinc plated
Approval	ICC-ES-ESR-2196 / ASTM C1513*
Environmental conditions	

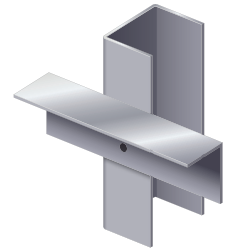

* Meets or exceeds ASTM C1513 performance requirements

Single screws

Description	Length L [in]	Diameter D [ga]	Drilling capacity [ga]	Drilling capacity [in]	Max. Thickness Fastened (MTF)	Drill point	Head diameter [in]	Pkg. quantity	Item no.
S-MD 8-18x1/2 PPH2	1/2	8	20 - 12	0.035 - 0.100	1/8" (0.125")	2	0.31	10000	311441

S-DD PTH 3

Application:

Medium gauge steel to steel applications

Fastening liner panel/light gauge to frame

Fastening profile steel sheets to light- and medium-gauge steel framing

Fastening resilient bar to interior steel profile

Steel framing, truss or joist fabrication

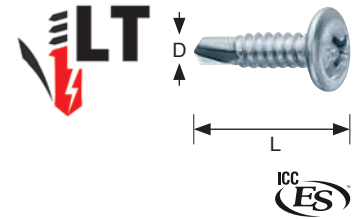
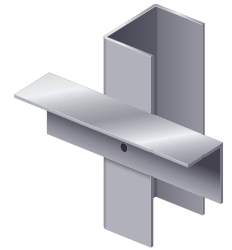

Technical data:

Screw design	Drill point - Fine thread - Truss
Insert bit type	head PH2
Material	Carbon steel
Coating	Zinc plated
Standard	ICC-ES-ESR-2196 / ASTM C1513*
Environmental conditions	

* Meets or exceeds ASTM C1513 performance requirements

Single screws

Description	Length L [in]	Diameter D [ga]	Drilling capacity [ga]	Drilling capacity [in]	Max. Thickness Fastened (MTF)	Drill point	Head diameter [in]	Pkg. quantity	Item no.
S-DD 10-18x3/4" PTH 3	3/4	10	12 - 7	0.110 - 0.175	3/8" (0.375")	3	0.43	5000	2297642

S-MD PPH #3

Application:

- Medium gauge steel to steel applications
- Fastening liner panel/light gauge to frame
- Fastening profile steel sheets to light- and medium-gauge steel framing
- Fastening resilient bar to interior steel profile
- Steel framing, truss or joist fabrication

Technical data:

Screw design	Drill point - Fine thread - Pan head
Insert bit type	PH2
Material	Carbon steel
Coating	Zinc plated
Approval	ICC-ES-ESR-2196 / ASTM C1513*
Environmental conditions	

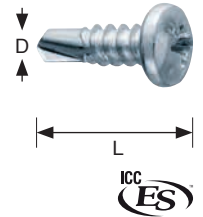
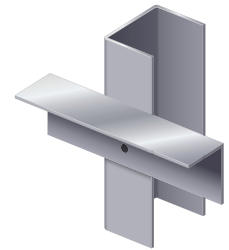

* Meets or exceeds ASTM C1513 performance requirements

Single screws

Description	Length L [in]	Diameter D [ga]	Drilling capacity [ga]	Drilling capacity [in]	Max. Thickness Fastened (MTF)	Drill point	Head diameter [in]	Pkg. quantity	Item no.
S-MD 10-16x5/8 PPH3	5/8	10	12 - 7	0.110 - 0.175	5/16" (0.313")	3	0.36	7500	2099042
S-MD 10-16x3/4 PPH3	3/4	10	12 - 7	0.110 - 0.175	3/8" (0.375")	3	0.36	6500	2099043

S-DD PFTH 3

Application:

- Medium gauge steel to steel applications
- Fastening liner panel/light gauge to frame
- Fastening profile steel sheets to light- and medium-gauge steel framing
- Fastening resilient bar to interior steel profile
- Steel framing, truss or joist fabrication

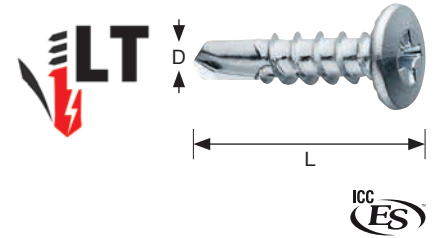
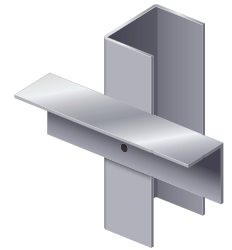

Technical data:

Screw design	Drill point - Fine thread - Flat truss head
Insert bit type	PH2
Material	Carbon steel
Coating	Zinc plated
Approval	ICC-ES-ESR-2196 / ASTM C1513*
Environmental conditions	

* Meets or exceeds ASTM C1513 performance requirements

Single screws

Description	Length L [in]	Diameter D [ga]	Drilling capacity [ga]	Drilling capacity [in]	Max. Thickness Fastened (MTF)	Drill point	Head diameter [in]	Pkg. quantity	Item no.
S-DD10-12x3/4 PFTH3	3/4	10	12 - 7	0.110 - 0.175	3/8" (0.375")	3	0.36	7500	2297640

S-DD PPCH 3

Application:

- Medium gauge steel to steel applications
- Fastening liner panel/light gauge to frame
- Fastening profile steel sheets to light- and medium-gauge steel framing
- Fastening resilient bar to interior steel profile
- Steel framing, truss or joist fabrication

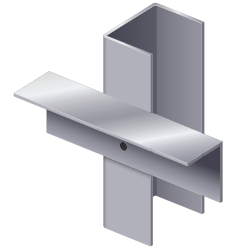

Technical data:

Screw design	Drill point - Fine thread - Pancake head
Insert bit type	PH2
Material	Carbon steel
Coating	Zinc plated
Approval	ICC-ES-ESR-2196 / ASTM C1513*
Environmental conditions	

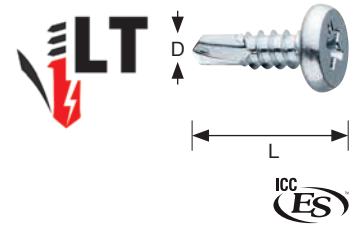

*Meets or exceeds ASTM C1513 performance requirements

Single screws

Description	Length L [in]	Diameter D [ga]	Drilling capacity [ga]	Drilling capacity [in]	Max. Thickness Fastened (MTF)	Drill point	Head diameter [in]	Pkg. quantity	Item no.
S-DD10-16x5/8 PPCH3	5/8	10	12 - 7	0.110 - 0.175	5/16" (0.313")	3	0.41	7500	2297641

S-DD TPCH #3 Z

Application:

Medium gauge steel to steel applications

Fastening liner panel/light gauge to frame

Fastening profile steel sheets to light- and medium-gauge steel framing

Fastening resilient bar to interior steel profile

Steel framing, truss or joist fabrication

Technical data:

Screw design	Drill point - Fine thread - Pancake head
Insert bit type	TX25HF (#2039138 for 10 pcs pack and 2039143 for 5 pcs pack)
Material	Carbon steel
Coating	Zinc plated
Approval	ICC-ES-ESR-2196 / ASTM C1513*
Environmental conditions	

*Meets or exceeds ASTM C1513 performance requirements

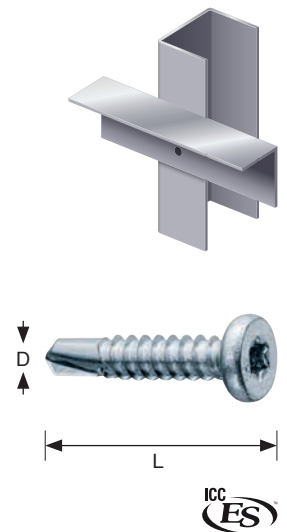

Single screws

Description	Length L [in]	Diameter D [ga]	Drilling capacity [ga]	Drilling capacity [in]	Max. Thickness Fastened (MTF)	Drill point	Head diameter [in]	Pkg. quantity	Item no.
S-DD 12-14x1 TPCH3	1	12	12 - 5	0.110 - 0.210	1/2" (0.500")	3	0.41	5000	2098865

S-MD HWH #2

Application:

Light gauge steel to steel applications

HVAC duct fabrication and installation

Accessories (electrical boxes, clips, etc.) to steel

Technical data:

Screw design	Drill point - coarse thread - hex head
Insert bit type	Hexagon 5/16", hexagon 1/4"
Material	Carbon steel
Coating	Zinc plated
Approval	ICC-ES-ESR-2196 / ASTM C1513*
Environmental conditions	

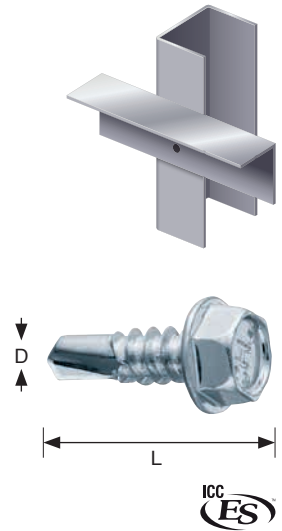

*Meets or exceeds ASTM C1513 performance requirements

Single screws

Description	Length L [in]	Diameter D [ga]	Drilling capacity [ga]	Drilling capacity [in]	Max. Thickness Fastened (MTF)	Insert bit type	Drill point	Head diameter [in]	Item no.
S-MD 8-18x1/2 HWH2	1/2	8	20 -12	0.035 - 0.100	1/8" (0.125")	Hex 1/4"	2	0.33	311438
S-MD 8-18x3/4 HWH2	3/4	8	20 -12	0.035 - 0.100	3/8" (0.375")	Hex 1/4"	2	0.33	311439
S-MD 10-16x1/2 HWH2	1/2	10	20 -12	0.035 - 0.110	3/16" (0.188")	Hex 5/16"	2	0.40	311445
S-MD 10-16x3/4 HWH2	3/4	10	20 -12	0.035 - 0.110	5/16" (0.313")	Hex 5/16"	2	0.40	311446
S-MD 10-16x1 HWH2	1	10	20 -12	0.035 - 0.110	1/2" (0.500")	Hex 5/16"	2	0.40	311447

S-MD 10 HWH #3

Application:

- Medium gauge steel to steel applications
- Fastening liner panel/light gauge to frame
- Fastening profile steel sheets to light- and medium-gauge steel framing
- Fastening resilient bar to interior steel profile
- Steel framing, truss or joist fabrication

Technical data:

Screw design	Drill point - coarse thread - hex head
Insert bit type	Hexagon 5/16"
Material	Carbon steel
Coating	Zinc plated
Approval	ICC-ES-ESR-2196 / ASTM C1513*
Environmental conditions	

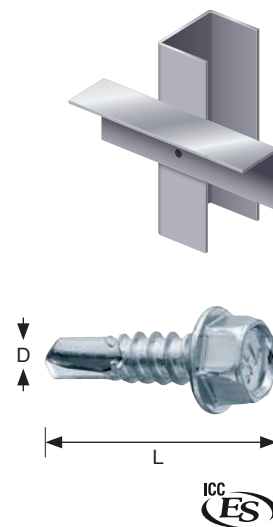

*Meets or exceeds ASTM C1513 performance requirements

Single screws

Description	Length L [in]	Diameter D [ga]	Drilling capacity [ga]	Drilling capacity [in]	Max. Thickness Fastened (MTF)	Drill point	Head diameter [in]	Pkg. quantity	Item no.
S-MD10-16x5/8 HWH3	5/8	10	12 - 7	0.110 - 0.175	3/16" (0.187")	3	0.40	7500	2098767
S-MD10-16x3/4 HWH3	3/4	10	12 - 7	0.110 - 0.175	3/8" (0.375")	3	0.40	6500	2098766
S-MD10-16x3/4 HHWH3 (High head)	3/4	10	12 - 7	0.110 - 0.175	3/8" (0.375")	3	0.40	6500	2098768
S-MD10-16x1 HWH3	1	10	12 - 7	0.110 - 0.175	5/8" (0.625")	3	0.40	5000	2098769
S-MD10-16x1-1/4 HWH3	1-1/4	10	12 - 7	0.110 - 0.175	7/8" (0.875")	3	0.40	4000	2099040
S-MD10-16x1-1/2 HWH3	1-1/2	10	12 - 7	0.110 - 0.175	1-1/8" (1.125")	3	0.40	4000	2099041
S-MD10-16x3/4 HWH3(CRC)*	3/4	10	12 - 7	0.110 - 0.175	3/8" (0.375")	3	0.40	6500	2313926
S-MD10 16x3/4HHWH3(CRC)*	3/4	10	12 - 7	0.110 - 0.175	3/8" (0.375")	3	0.40	6500	2313929

*1.000 hour corrosion resistance under salt spray test as per ASTM B117

S-MD 12 HWH #3

Application:

- Medium gauge steel to steel applications
- Fastening liner panel/light gauge to frame
- Fastening profile steel sheets to light- and medium-gauge steel framing
- Fastening resilient bar to interior steel profile
- Steel framing, truss or joist fabrication

Technical data:

Screw design	Drill point - coarse thread - hex head
Insert bit type	Hexagon 5/16"
Material	Carbon steel
Coating	Zinc plated
Approval	ICC-ES-ESR-2196 / ASTM C1513*
Environmental conditions	

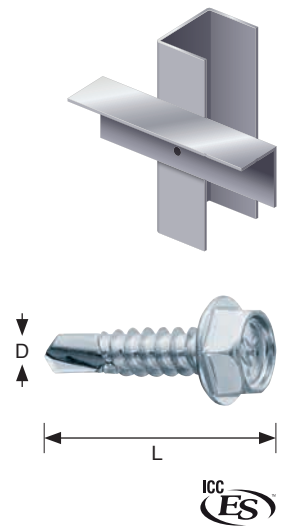

* Meets or exceeds ASTM C1513 performance requirements

Single screws

Description	Length L [in]	Diameter D [ga]	Drilling capacity [ga]	Drilling capacity [in]	Max. Thickness Fastened (MTF)	Drill point	Head diameter [in]	Pkg. quantity	Item no.
S-MD12-14x3/4 HWH3	3/4	12	12 - 5	0.110 - 0.210	5/16" (0.313")	3	0.43	5000	2099044
S-MD12-14x1 HWH3	1	12	12 - 5	0.110 - 0.210	9/16" (0.562")	3	0.43	3000	2099045
S-MD12-14x1-1/2 HWH3	1-1/2	12	12 - 5	0.110 - 0.210	1-1/16" (1.062")	3	0.43	2500	2099046
S-MD12-14x2 HWH3	2	12	12 - 5	0.110 - 0.210	1-9/16" (1.562")	3	0.43	2000	2099047

S-MD 12 HWH #4

Application:

Heavy gauge steel to steel applications

Fastening multiple layers of metal to steel

Fastening accessories (clips, etc.) to structural members

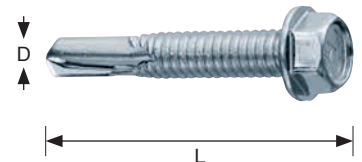
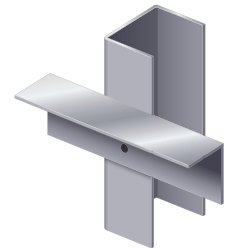

Technical data:

Screw design	Drill point - coarse thread - hex head
Insert bit type	Hexagon 5/16"
Material	Carbon steel
Coating	Zinc plated
Approval	ICC-ES-ESR-2196 / ASTM C1513*
Environmental conditions	

* Meets or exceeds ASTM C1513 performance requirements

Single screws

Description	Length L [in]	Diameter D [ga]	Drilling capacity [ga]	Drilling capacity [in]	Max. Thickness Fastened (MTF)	Drill point	Head diameter [in]	Pkg. quantity	Item no.
S-MD12-24x7/8 HWH4	7/8	12	7 - 3	0.175 - 0.250	3/8" (0.375")	4	0.41	4500	2099052
S-MD12-24x1-1/4HWH4	1-1/4	12	7 - 3	0.175 - 0.250	5/8" (0.625")	4	0.42	3500	2099053
S-MD12-24x7/8 HWH4(CRC)*	7/8	12	7 - 3	0.175 - 0.250	3/8" (0.375")	4	0.41	4500	2313928

*1.000 hour corrosion resistance under salt spray test as per ASTM B117

S-MD 12 HWH #5

Application:

Heavy gauge steel to steel applications
 Fastening multiple layers of metal to steel
 Fastening accessories (clips, etc.) to structural members

Technical data:

Screw design	Drill point - coarse thread - hex head
Insert bit type	Hexagon 5/16"
Material	Carbon steel
Coating	Zinc plated
Approval	ICC-ES-ESR-2196 / ASTM C1513*
Environmental conditions	

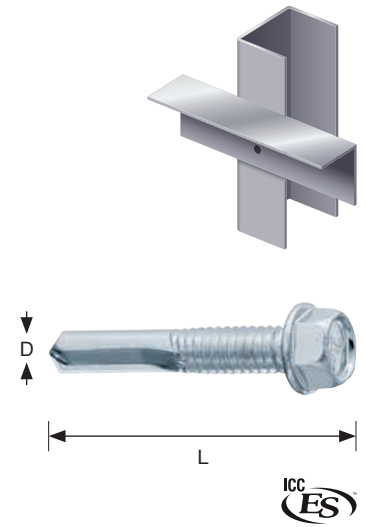

* Meets or exceeds ASTM C1513 performance requirements

Single screws

Description	Length L [in]	Diameter D [ga]	Drilling capacity [ga]	Drilling capacity [in]	Max. Thickness Fastened (MTF)	Drill point	Head diameter [in]	Pkg. quantity	Item no.
S-MD12-24x1-1/4HWH5	1-1/4	12	-	0.250 - 0.500	7/16" (0.437")	5	0.41	3500	2099054

S-MD HHWH STITCH/PILOT

Application:

Self-drilling hex head screw (zinc-plated) for fastening sheet metal to steel substructures

Sidelap (unsupported metal sheets)

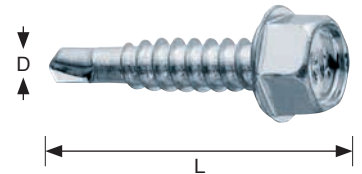
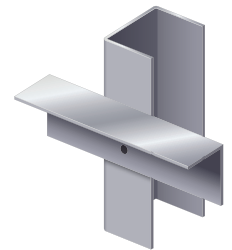

Technical data:

Screw design	Drill point - coarse thread - hex head
Insert bit type	Hexagon 5/16"
Material	Carbon steel
Coating	Zinc plated
Approval	ICC-ES-ESR-2196 / ASTM C1513*
Environmental conditions	

* Meets or exceeds ASTM C1513 performance requirements

Single screws

Description	Length L [in]	Diameter D [ga]	Drilling capacity [ga]	Drilling capacity [in]	Max. Thickness Fastened (MTF)	Drill point	Head diameter [in]	Pkg. quantity	Item no.
S-MD 10-16x7/8 HHWH Pilot point	7/8	10	22 -10	0.028 - 0.120	3/16" (0.188")	1	0.41	6000	312011
S-MD 12-14x1 HHWH STITCH	1	12	22 -10	0.028 - 0.120	3/8" (0.375")	2	0.42	3000	312010

S-MD 1/4-14 HHWH #3

Application:
Medium gauge steel to steel applications

Technical data:

Screw design	Drill point - coarse thread - hex head
Insert bit type	Hexagon 3/8"
Material	Carbon steel
Coating	Zinc plated
Approval	ICC-ES-ESR-2196 / ASTM C1513*
Environmental conditions	

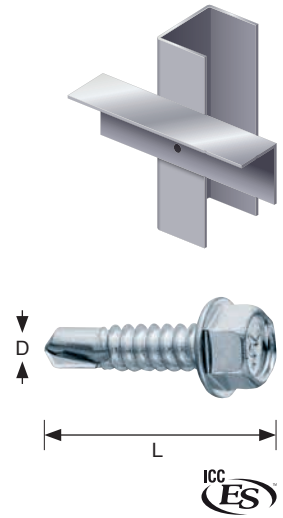

* Meets or exceeds ASTM C1513 performance requirements

Single screws

Description	Length L [in]	Diameter D [ga]	Drilling capacity [ga]	Drilling capacity [in]	Max. Thickness Fastened (MTF)	Drill point	Head diameter [in]	Pkg. quantity	Item no.
S-MD 1/4-14x3/4 HHWH3	3/4	1/4	12 - 4	0.110 - 0.220	5/16" (0.313")	3	0.50	4000	2099048
S-MD 1/4-14x1 HHWH3	1	1/4	12 - 4	0.110 - 0.220	9/16" (0.562")	3	0.50	3000	2099049
S-MD 1/4-14x1-1/2 HHWH3	1-1/2	1/4	12 - 4	0.110 - 0.220	1-1/16" (1.062")	3	0.50	2000	2099050
S-MD 1/4-14x2 HHWH3	2	1/4	12 - 4	0.110 - 0.220	1-9/16" (1.562")	3	0.50	1000	2099051

S-WD PFH #3

Application:

Fastening untreated plywood to steel framing

Fastening metal-backed gypsum sheets

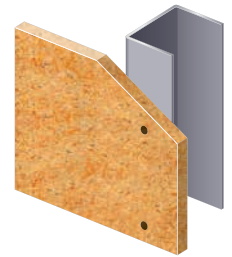

Technical data:

Screw design	Drill point with wings - Fine thread - Countersunk head
Insert bit type	PH2
Material	Carbon steel
Coating	Phosphated
Approval	-
Environmental conditions	

Single screws

Description	Length L [in]	Diameter D [ga]	Drilling capacity [ga]	Drilling capacity [in]	Max. Thickness Fastened (MTF)	Drill point	Head diameter [in]	Pkg. quantity	Item no.
S-WD 8-18x1-5/16 PFH3	1-5/16	8	18 - 9	0.050 - 0.140	1/2" (0.500")	3	0.33	6000	311629
S-WD 8-18x1-15/16 PFH3	1-15/16	8	18 - 9	0.050 - 0.140	3/4" (0.750")	3	0.33	4000	311630

Collated screws for SD-M 1 and SD-M 2

Description	Length L [in]	Diameter D [ga]	Drilling capacity [ga]	Drilling capacity [in]	Head diameter [in]	Pkg. quantity	SD-M 1	SD-M 2	Item no.
S-WD 8-18x1-15/16 PFH3 M1	1-15/16	8	18 - 9	0.050 - 0.140	0.33	1000		■	2276738

S-WD PWH #3

Application:
Fastening untreated wood and plywood to steel framing
Fastening exterior sheathing

Technical data:

Screw design	Drill point - Fine thread - Bugle head
Insert bit type	PH2
Material	Carbon steel
Coating	Zinc plated
Approval	-
Environmental conditions	

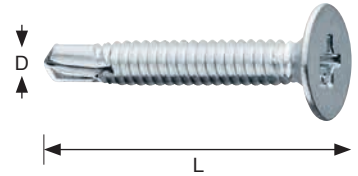
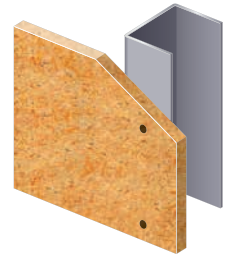

Single screws

Description	Length L [in]	Diameter D [ga]	Drilling capacity [ga]	Drilling capacity [in]	Max. Thickness Fastened (MTF)	Drill point	Head diameter [in]	Pkg. quantity	Item no.
S-WD 10-24x1 PWH3	1	10	18 - 7	0.050 - 0.175	5/8" (0.625")	3	0.46	6000	311632
S-WD 10-24x1-1/4 PWH3	1-1/4	10	18 - 7	0.050 - 0.175	7/8" (0.875")	3	0.46	5000	311633
S-WD 10-24x1-1/2 PWH3	1-1/2	10	18 - 7	0.050 - 0.175	1-1/8" (1.125")	3	0.46	3500	311634

S-WW WINGED REAMER SCREW - PWH 3

Application:

Fastening untreated plywood to steel framing
 Fastening wood to steel member

Technical data:

Screw design	Drill point with wings - Fine thread - Wafer head
Insert bit type	PH2
Material	Carbon steel
Coating	Zinc plated
Standard	-
Environmental conditions	

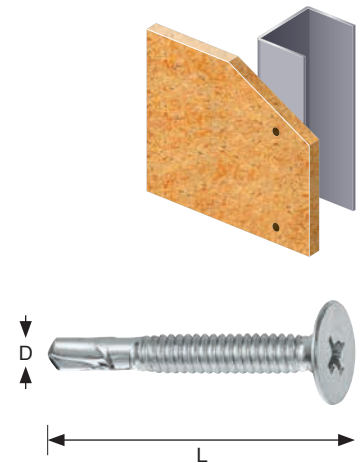

Single screws

Description	Length L [in]	Diameter D [ga]	Drilling capacity [ga]	Drilling capacity [in]	Max. Thickness Fastened (MTF)	Drill point	Head diameter [in]	Pkg. quantity	Item no.
10-24x1-7/16" PWH 3	1 7/16	10	18 - 7	0.050 - 0.175	3/4" (0.750")	3	0.47	4000	311635

S-WW WINGED REAMER SCREW - PFH 4

Application:

Fastening untreated plywood to steel framing
Fastening wood to steel member

Technical data:

Screw design	Drill point with wings - Fine thread - Flat head
Insert bit type	PH3
Material	Carbon steel
Coating	Zinc plated
Approval	-
Environmental conditions	

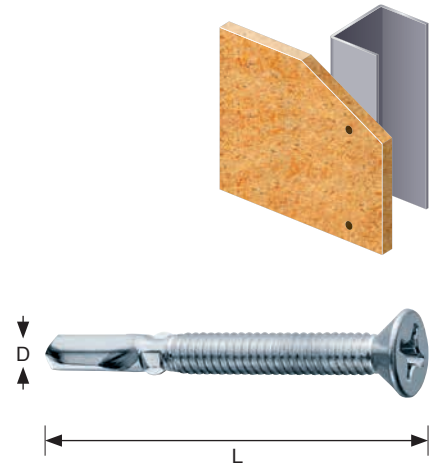

Single screws

Description	Length L [in]	Diameter D [ga]	Drilling capacity [ga]	Drilling capacity [in]	Max. Thickness Fastened (MTF)	Drill point	Head diameter [in]	Pkg. quantity	Item no.
12-24x2" PFH 4	2	12	18 - 4	0.050 - 0.232	1 1/4" (1.250")	4	0.46	2000	311636
12-24x2-1/2" PFH 4	2-1/2	12	18 - 4	0.050 - 0.232	1 3/4" (1.750")	4	0.46	1500	311637
1/4-20x2-3/4" PFH 4	2-3/4	12	18 - 3	0.050 - 0.250	2" (2.000")	4	0.46	1000	311638
12-24x2 1/2" PFH4 (CRC)*	2-1/2	12	18 - 4	0.050 - 0.232	1 3/4" (1.750")	4	0.46	1500	2297635
1/4-20x2 3/4" PFH4 (CRC)*	2-3/4	12	18 - 3	0.050 - 0.250	2" (2.000")	4	0.46	1000	2297636

*1.000 hour corrosion resistance under salt spray test as per ASTM B117

SFH SD

Application:

Fastening wood trim and base to studs (20 ga - 14 ga)

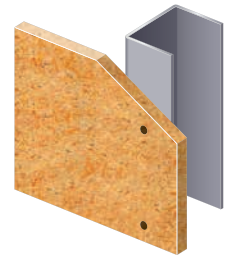

Technical data:

Screw design	Drill point - Fine thread - Countersunk flat head
Insert bit type	Square
Material	Carbon steel
Coating	Phosphated
Approval	-
Environmental conditions	

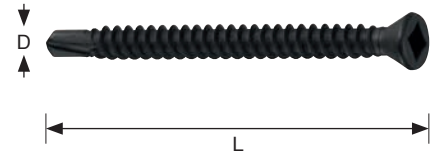

Single screws

Description	Length L [in]	Diameter D [ga]	Drilling capacity [ga]	Drilling capacity [in]	Head diameter [in]	Pkg. quantity	Item no.
6x1-5/8" SFH SD TRIM	1 5/8	6	20 - 14	0.033 - 0.088	0.47	5000	86233

SFH SD ZINC

Application:

Fastening wood trim and base to studs (20 ga - 14 ga)

Technical data:

Screw design	Drill point - Fine thread - Countersunk flat head
Insert bit type	Square
Material	Carbon steel
Coating	Zinc plated
Approval	-
Environmental conditions	

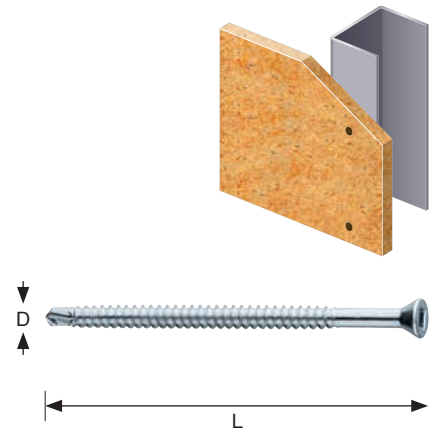

Single screws

Description	Length L [in]	Diameter D [ga]	Drilling capacity [ga]	Drilling capacity [in]	Head diameter [in]	Pkg. quantity	Item no.
6x2-1/4" SFH SD TRIM ZN	2 1/4	6	20 -14	0.033 - 0.088	0.47	3000	86236

SFH S

Application:
Fastening wood trim and base to studs (25 ga - 20 ga)

Technical data:

Screw design	Drill point - Fine thread - Countersunk flat head
Insert bit type	Square
Material	Carbon steel
Coating	Phosphated
Approval	-
Environmental conditions	

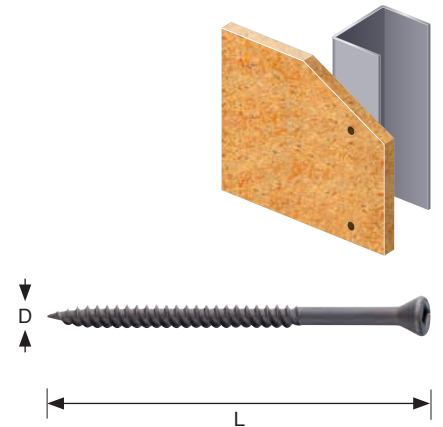

Single screws

Description	Length L [in]	Diameter D [ga]	Drilling capacity [ga]	Drilling capacity [in]	Head diameter [in]	Pkg. quantity	Item no.
6x2-1/4" SFH S TRIM	2 1/4	6	25 - 20	0.023 - 0.033	0.43	3000	84331

EYE LAG CEILING FASTENING HANGER

Application:

Eye lag screw with a hole for suspended ceiling applications to wood or metal

Technical data 1/4" x 3" EL WS (#388249) and 1/4" x 4" EL WS (#388251):

Base material	Wood
Material	Carbon steel
Coated	Zinc plated
Length [in]	4
Item number	388249, 388251
Pkg. quantity	100
Environmental conditions	

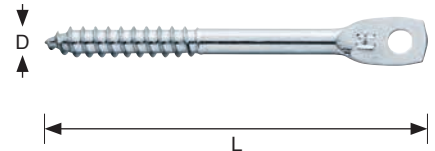

Technical data 1/4" x 2-3/4" EL S:

Base material	Steel 25 - 20 ga and wood
Material	Carbon steel
Coated	Zinc plated
Length [in]	2 3/4
Item number	288574
Pkg. quantity	100
Environmental conditions	

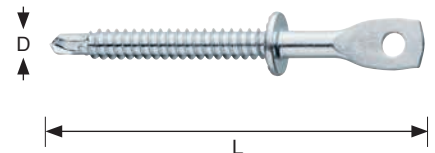

Technical data 1/4" x 2" EL SD (#388245) and 1/4" x 3" EL SD (#388247):

Base material	Steel 22 - 16 ga
Material	Carbon steel
Coated	Zinc plated
Length [in]	2
Item number	388245, 388247
Pkg. quantity	100
Environmental conditions	

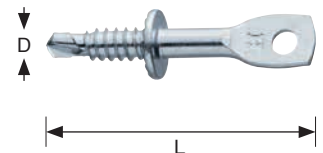

INSTALLATION INSTRUCTIONS FOR EYE LAG CEILING FASTENING HANGER*

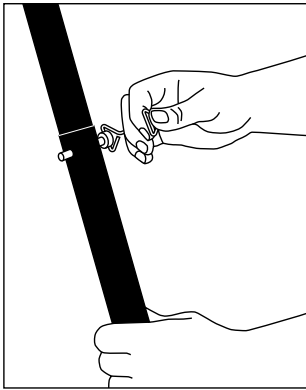

1. Adjust the telescoping tubes to the proper lengths.

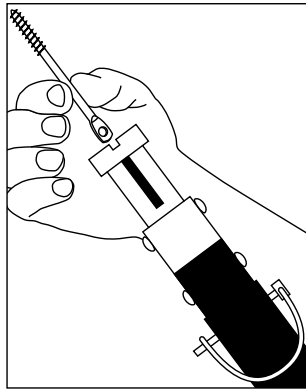

2. Insert the Eye Lag screw into top slot.

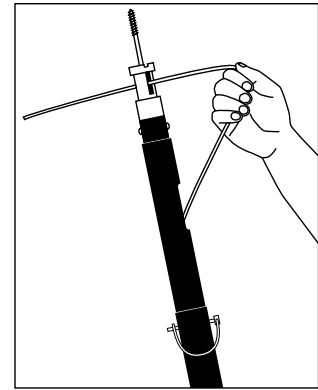

3. Insert wire into side of slot through the eyelet in the Eye Lag screw. Then bend the wire end down. Provide adequate length of wire to properly develop the required number of loops after twisting.

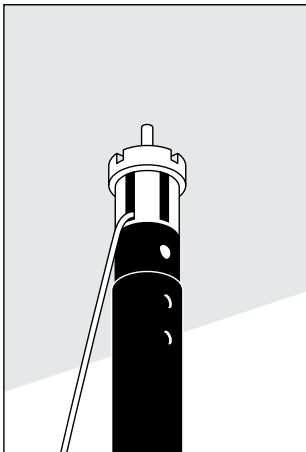

4. Raise tool against the ceiling, rotate the pole tool until the Eye Lag screw is at least 1-1/2" into the wood base material (embedment varies for steel base material) CAUTION: In steel base material, stop turning before washer contacts base material to avoid stripping of the base steel.

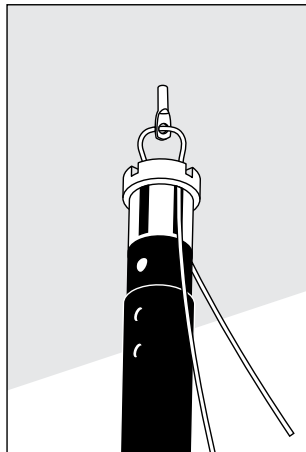

5. Lower the tool about 2" from base material surface as shown.

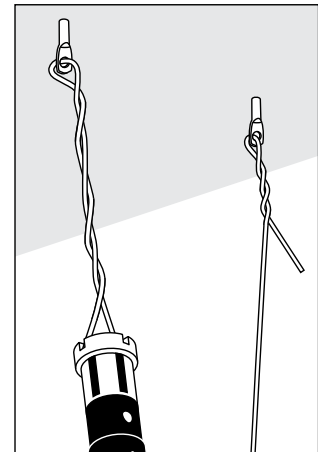

6. Rotate the tool again to twist the wire. The pole tool may be turned by hand or by using a 1/2" variable speed drill. CAUTION: If using drill, do not grip pole tightly with hand, but allow it to turn loosely.

* These are abbreviated instructions which may vary by application. **ALWAYS** review/follow the instructions accompanying the product.

5. OVERVIEW OF TOOLS AND ACCESSORIES

Cordless drywall screwdriver SD 5000-A22



Ordering description	Content	Sales quantity	Item number
Cordless drywall screwdriver SD 5000-A22 cardboard box	1 x SD 5000-A22 1 x Bit S-B PH2 25/1" IF 1 x Bit holder S-BH M 50/2" 1 x Depth gauge S-DG	1 pc	2236890

Corded drywall screwdriver SD 4500 120V



Ordering description	Content	Sales quantity	Item number
Corded drywall screwdriver SD 4500 120V cardboard box	1 x SD 4500 120V 15' cord 1 x Bit S-B PH2 26/1" IF 1 x Bit holder S-BH M 50/2" 1 x Depth gauge S-DG	1 pc	2020087

Corded wood/drywall screwdriver SD 2500 120V



Ordering description	Content	Sales quantity	Item number
Corded wood/drywall screwdriver SD 2500 120V cardboard box	1 x SD 2500 120V 1 x Bit S-B PH2 26/1" IF 1 x Bit holder S-BH M 75/3"	1 pc	285703

Screw magazine SD-M 1



Ordering description	Content	Sales quantity	Item number
Screw magazine SD-M 1	1 x SD-M 1 1 x Bit S-SY PH2 81/3 1/4"	1 pc	2208484

Screw magazine SD-M 2



Ordering description	Content	Sales quantity	Item number
Screw magazine SD-M 2	1 x SD-M 2 1 x Bit S-SY PH2 102/4"	1 pc	2208485

Adapter SD-DWA



Ordering description	Content	Sales quantity	Item number
SD-DWA	1 x SD-DWA 1 x Bit S-SY PH2 153/6"	1 pc	2252536

Extension tube SME



Ordering description	Content	Sales quantity	Item number
Extension tube SME	1 x Extension tube 1 x Bit holder S-BH 570 SME 1 x Side handle	1 pc	304495
Spare bit holder S-BH 570 SME		1 pc	304741

Pole tube SF PT for fastening eye lag ceiling fastening hanger



Ordering description	Content	Sales quantity	Item number
Pole tube SF PT 4" - 12 "		1 pc	289875
Pole tube SF PT 8" - 12 "		1 pc	289876

Magnetic bit holders S-BH M



Ordering description	Sales quantity	Item number
Magnetic bit holder S-BH M 50/2"	1	2038758
Magnetic bit holder S-BH M 75/3"	1	2038759
Magnetic bit holder S-BH M 152/6"	1	2039211

Magnetic bit holders (impact) S-BH



Ordering description	Sales quantity	Item number
Bit holder S-BH IMP 75/3" RM 1 pk	1	2039216

Insert bits S-B (IF)



Ordering description	Sales quantity	Item number
Driver bit S-B PH2 25/1" IF 10 pk	10	2039035
Driver bit S-B PH2 25/1" IF 100 pk	100	2039036
Driver bit S-B PH2 25/1" IF 250 pk	250	2039037
Driver bit S-B PH2 25/1" S 10 pk	10	2039032
Driver bit S-B PH2 25/1" S 100 pk	100	2039033
Driver bit S-B PH2 25/1" S 250 pk	250	2039034
Driver bit S-B PH2 50/2" S 25 pk	25	2039082

Insert bits (impact) S-B (IF)



Ordering description	Sales quantity	Item number
Driver bit S-B PH2 50/2" IMP 5 pk	5	2039126
Driver bit S-B PH2 25/1" IMP 10 pk	10	2039116

Insert bits (diamonds) S-B (T-D)



Ordering description	Sales quantity	Item number
Driver bit S-B PH2 25/1" T-D 10 pk	10	2039038

Insert bits for SD-M 1



Material description	Sales quantity	Item number
Driver bit S-SY PH2 81/3-1/4" 5 pk	5	2039290
Driver bit S-SY PH2 81/3-1/4" 10 pk	10	2039291

Insert bits for SD-M 2



Material description	Sales quantity	Item number
Driver bit S-SY PH2 102/4" 5 pk	5	2131008
Driver bit S-SY PH2 102/4" 10 pk	10	2131009

Insert bits for SD-DWA



Material description	Sales quantity	Item number
Driver bit S-SY PH2 153/6"	5	2252537

Magnetic nut setters for the hex head framing screws



Material description	Sales quantity	Item number
Nut Setter S-NS 1/4" M 50/2"	1	2039230
Nut Setter S-NS 5/16" M 50/2"	1	2039231
Nut Setter S-NS 3/8" M 50/2"	1	2039232
Nut Setter S-NS 5/16" M 65/2 1/2"	1	2039233
Nut Setter S-NS 3/8" M 65/2 1/2"	1	2039234
Nut Setter S-NS 1/2" M 50/2"	1	2045996

Non-magnetic nut setters for the hex head framing screws



Material description	Sales quantity	Item number
Nut Setter S-NS 5/16" C 50/2"	1	2039249
Nut Setter S-NS 3/8" C 50/2"	1	2039250

Torx insert bits S-B (T)



Material description	Sales quantity	Item number
Driver bit S-B TX25 25/1" T 10pk	10	2039059
Driver bit S-B TX25 25/1" T-HF 10 pk	10	2039138
Driver bit S-B TX25 50/2" T-HF 5 pk	5	2039143

PH3 insert bits S-B (S)

Ordering description	Sales quantity	Item number
Driver bit S-B PH3 25/1" S 10 pk	10	2039041

SQ2 insert bits S-B (S)

Ordering description	Sales quantity	Item number
Driver bit S-B SQ2 25/1" S 10 pk	10	2039074



Hilti Corporation
9494 Schaan, Liechtenstein
P +423-234 2965

www.facebook.com/hiltigroup
www.hilti.group